

MASONRY TYPE "A"

ALUMINUM WINDOW

GLASS BALCONY RAILING

ALUMINUM GLAZING SYSTEM

MASONRY TYPE "B"

ALUMINUM GLAZING SYSTEM

GRANITE BASE

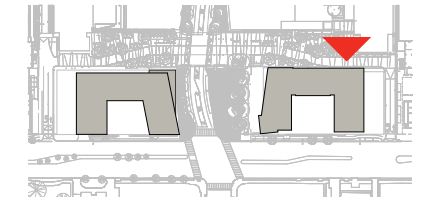
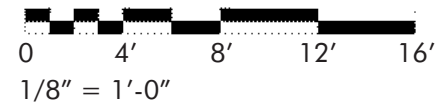

MATCH LINE 84

MATCH LINE 86

ALUMINUM GLAZING SYSTEM

MASONRY TYPE "A"

ALUMINUM GLAZING SYSTEM

GRANITE BASE

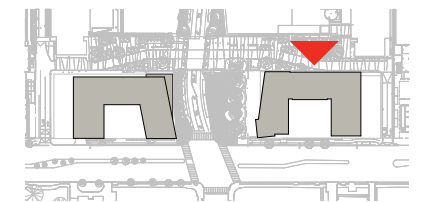

MATCH LINE 85

ALUMINUM GLAZING SYSTEM

ALUMINUM WINDOW

MASONRY TYPE "A"

GLASS BALCONY RAILING

STRUCTURALLY GLAZED STOREFRONT SYSTEM

ALUMINUM GLAZING SYSTEM

GRANITE BASE

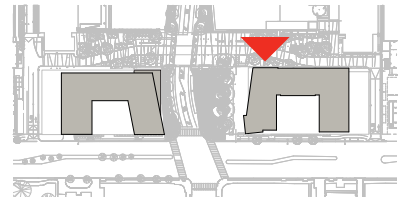
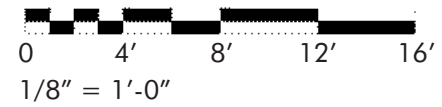

MASONRY TYPE "A"

ALUMINUM WINDOW

GLASS BALCONY RAILING

ALUMINUM GLAZING SYSTEM

ALUMINUM GLAZING SYSTEM

MASONRY TYPE "B"

GRANITE BASE

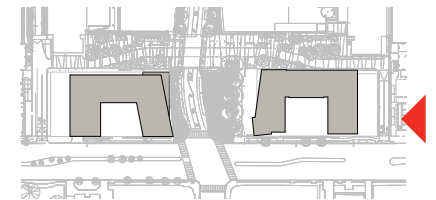
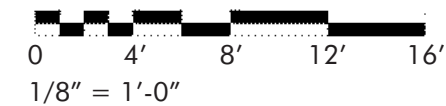

MATCH LINE 87

MASONRY TYPE "A"

ALUMINUM WINDOW

ALUMINUM GLAZING SYSTEM

MASONRY TYPE "B"

ROLLING GRILLE (PARKING)

OVERHEAD DOOR (SERVICE/LOADING)

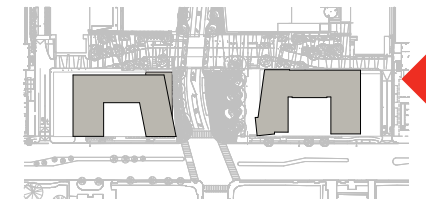
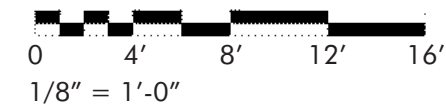



1. ALUMINUM GLAZING SYSTEM - MULLIONS



3. WOOD-LIKE CLADDING

2. TOWER - MASONRY TYPE "A" 4. ALUMINUM WINDOW



5. RETAIL PODIUM - MASONRY TYPE "B"



6. WATER TABLE - GRANITE BASE



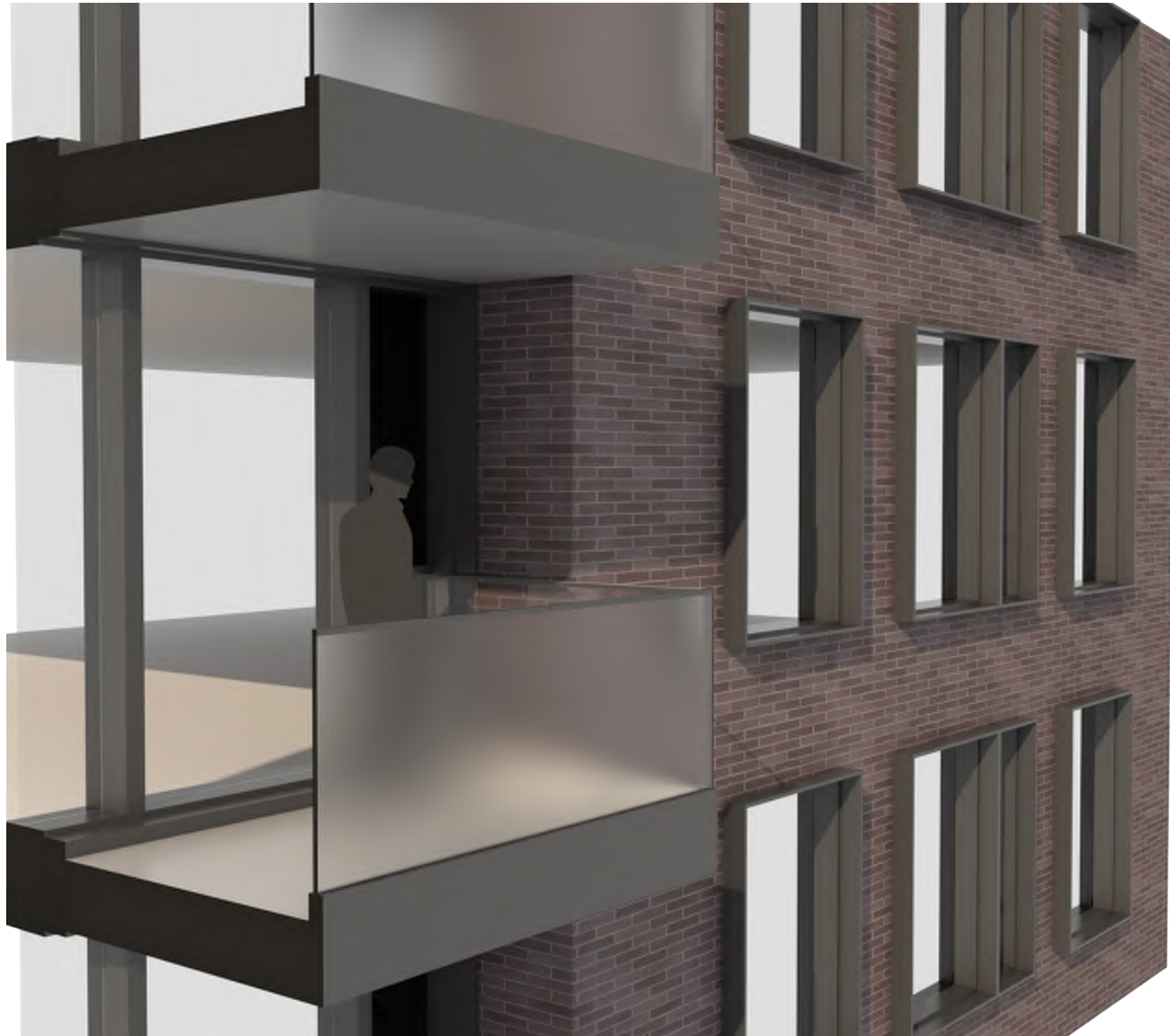

SECTION

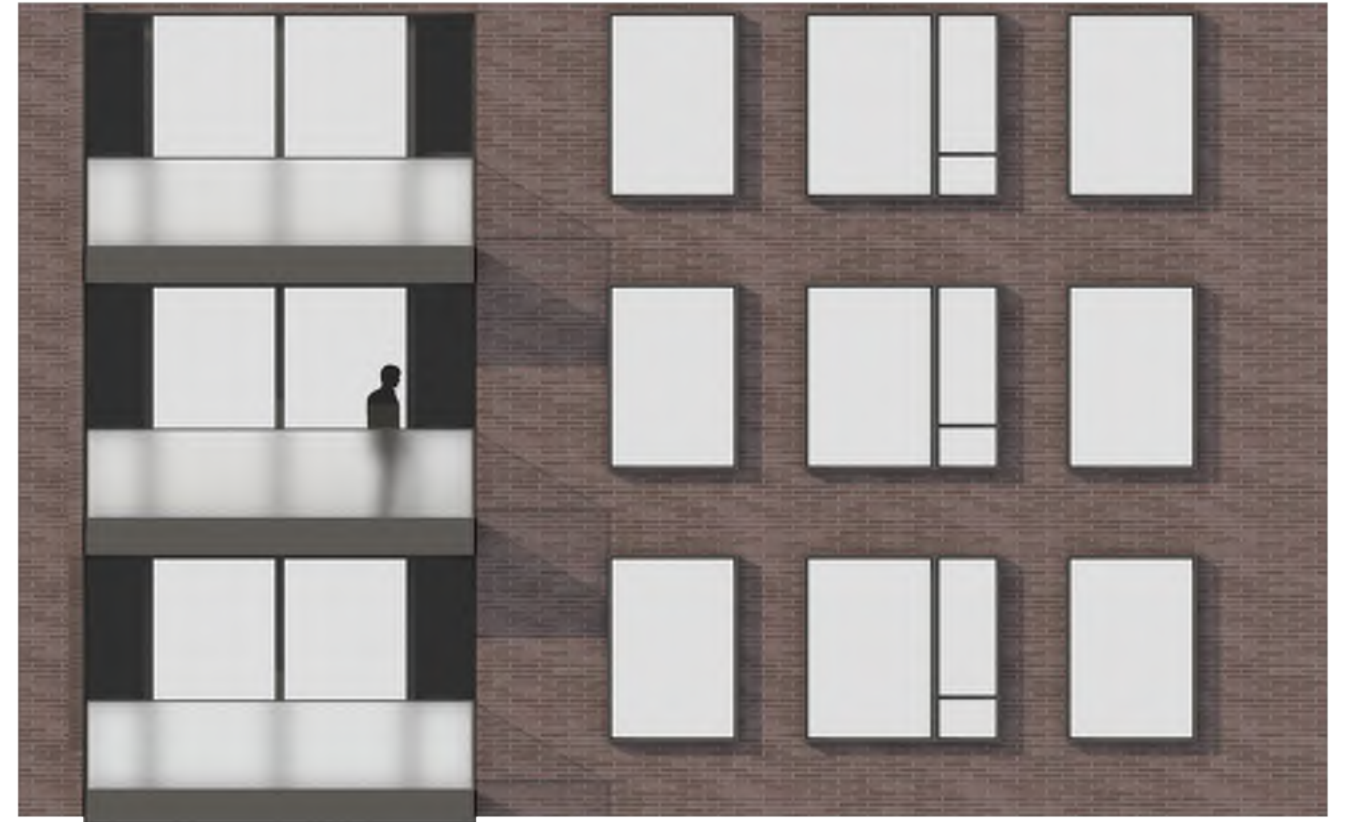

ELEVATION



SECTION



ELEVATION

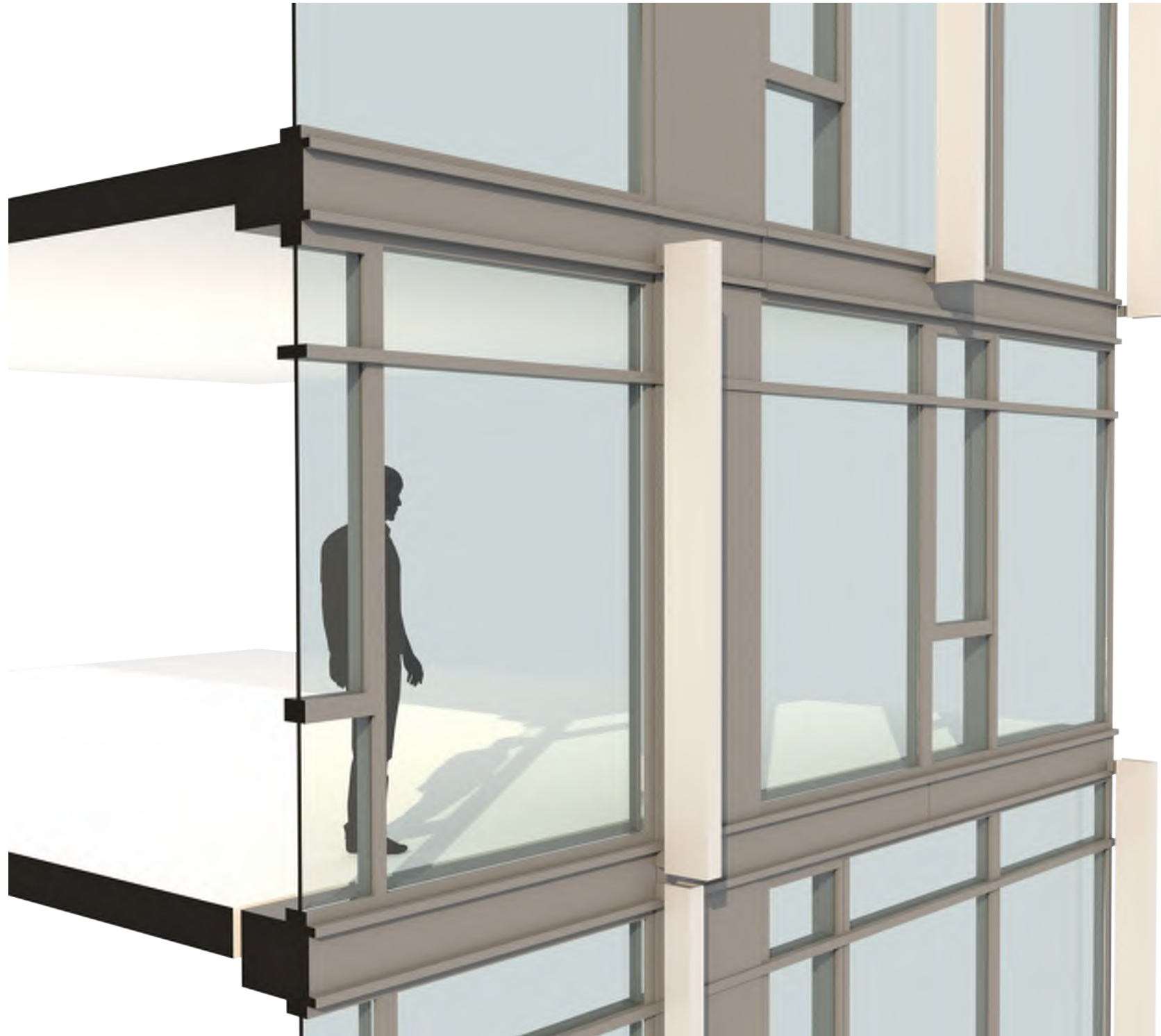

SECTION

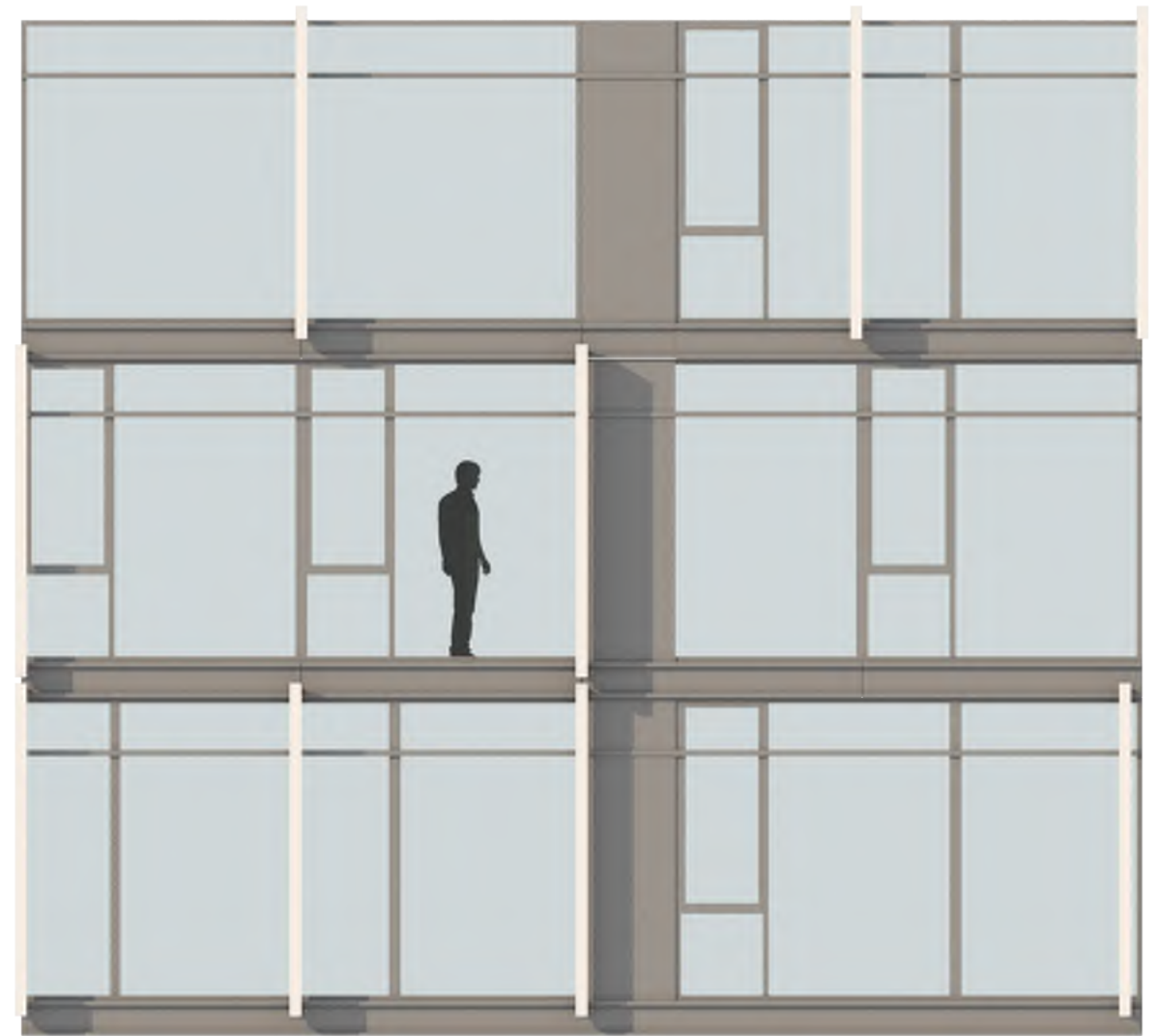

ELEVATION

PAGE INTENTIONALLY
LEFT BLANK

STAGE 2 PUD - SECTIONS

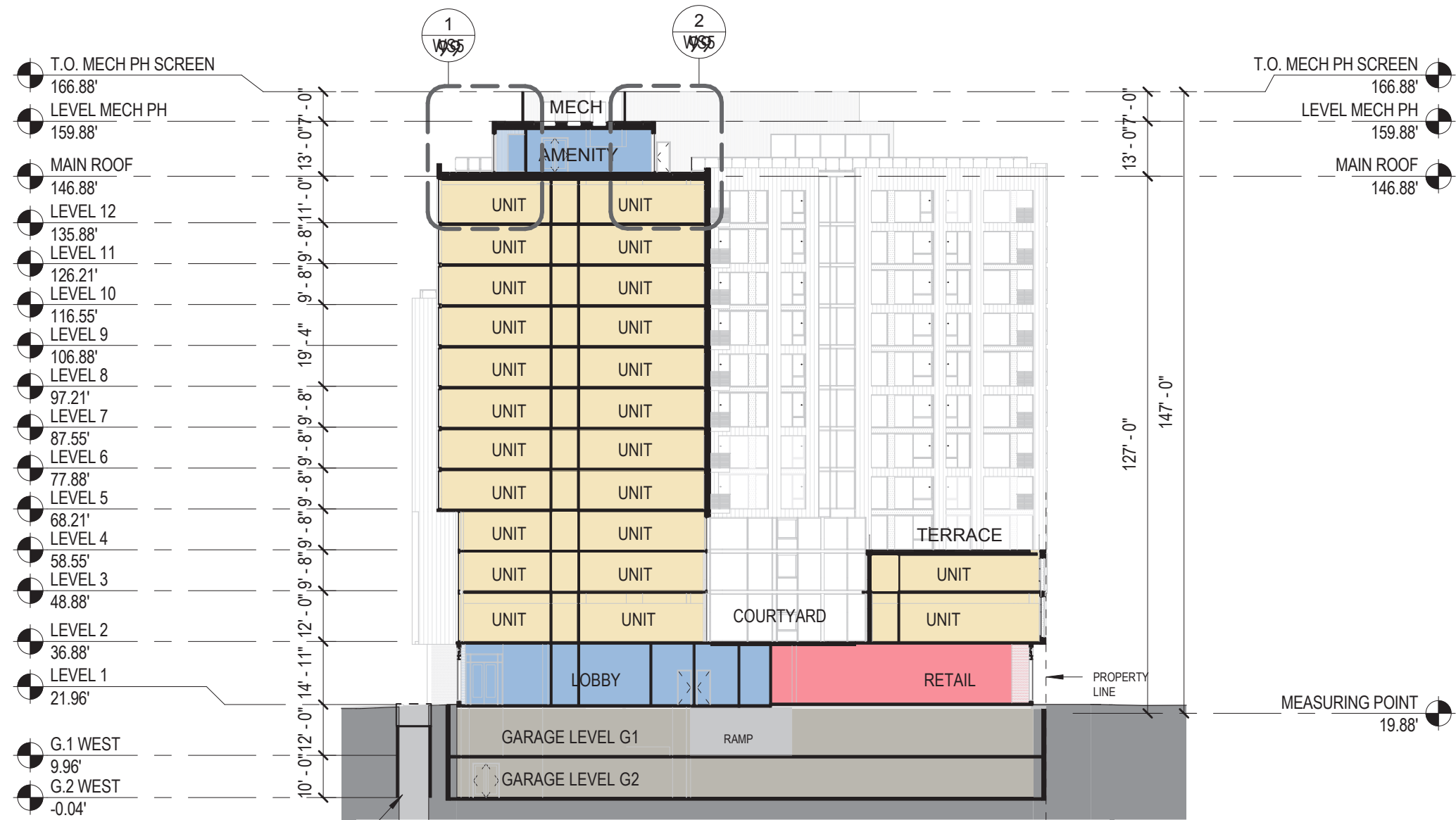

1 **PUD - WEST BLDG SECTION - NORTH SOUTH**
1/32" = 1'-0"

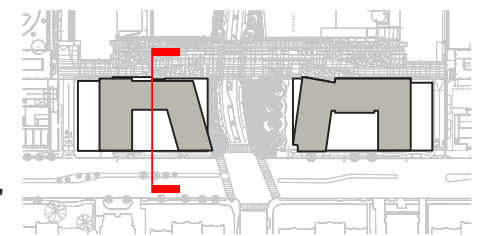
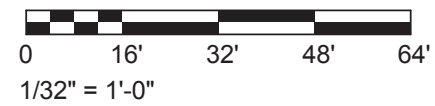

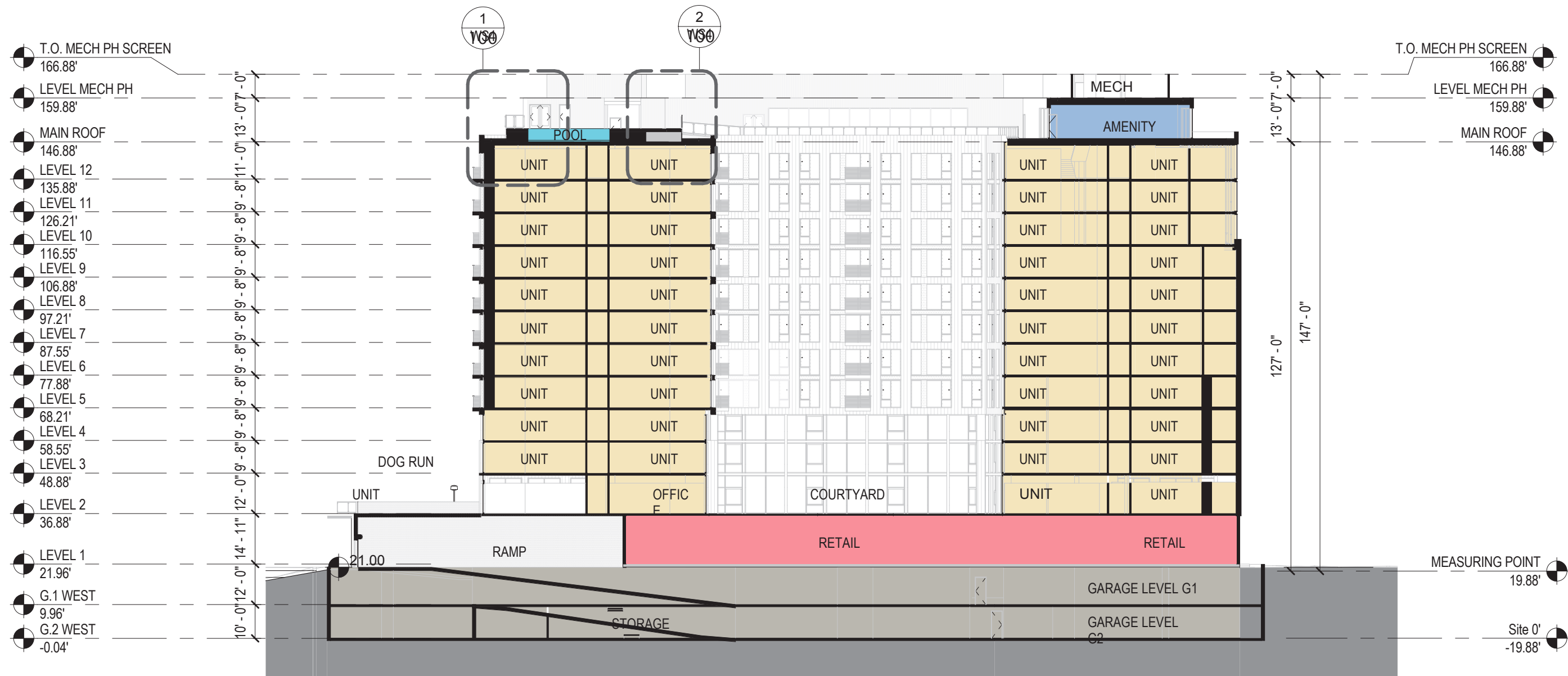

1 PUD - WEST BLDG SECTION - EAST WEST
1/32" = 1'-0"

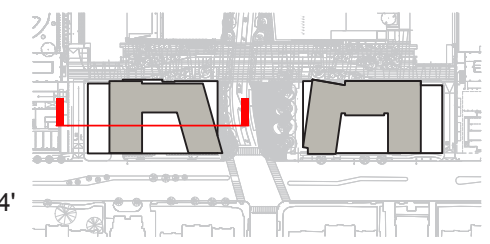
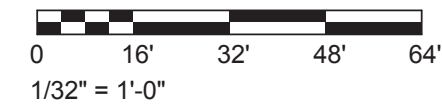

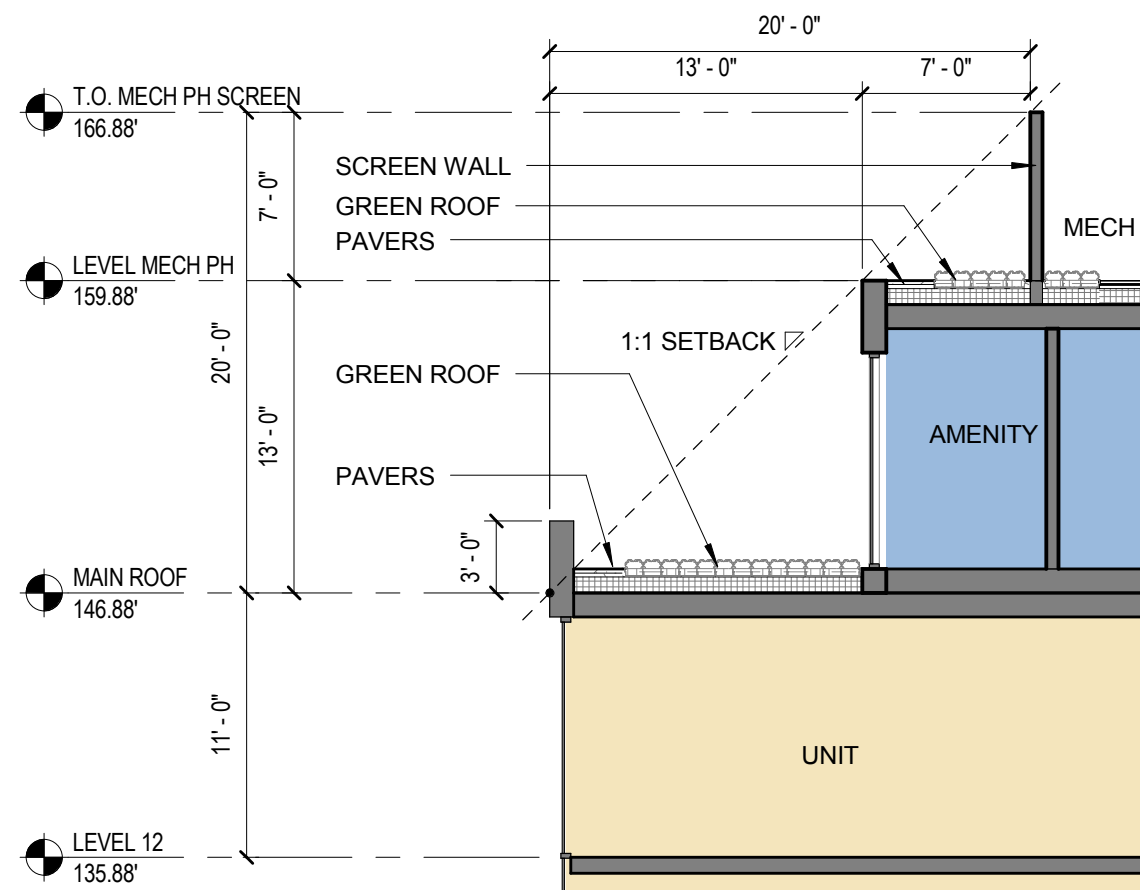

1 ENLARGED SECTION 1
1/8" = 1'-0"

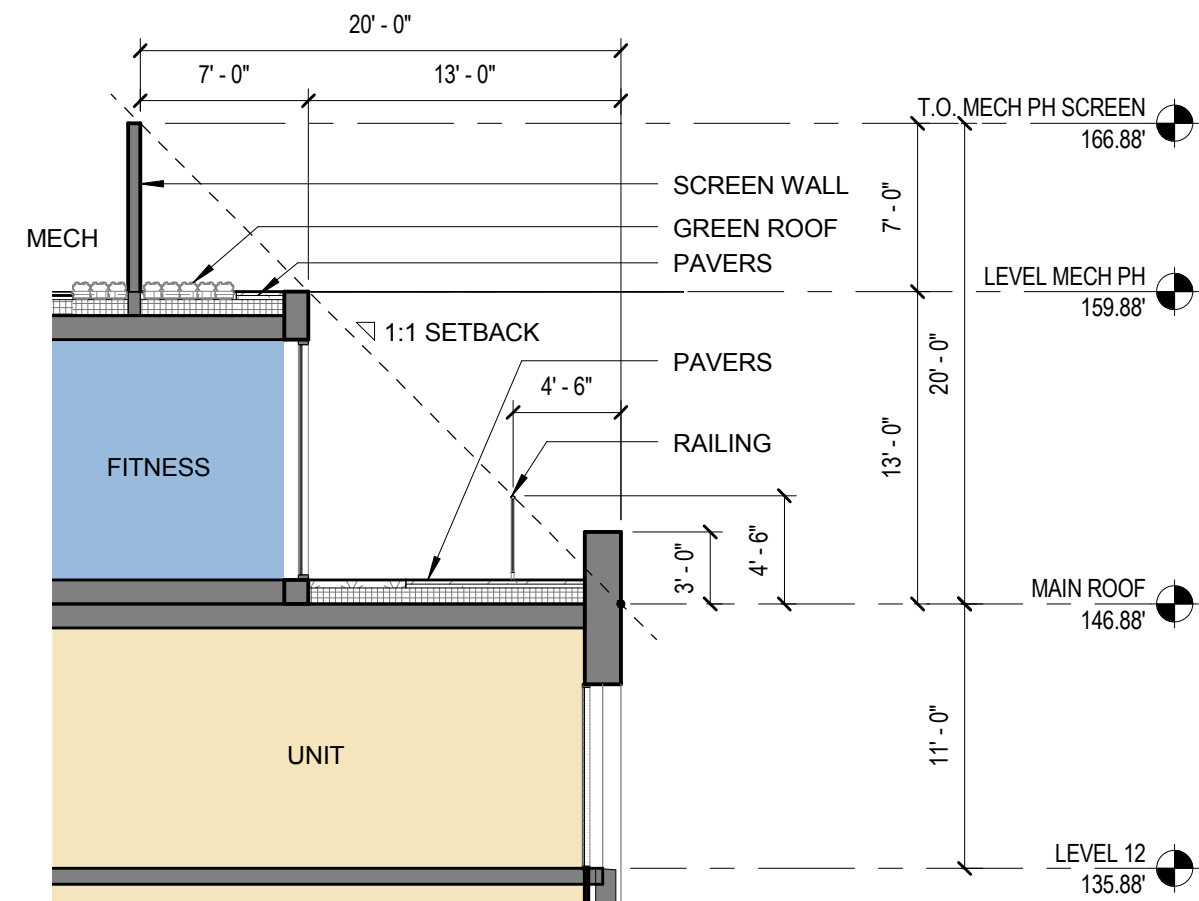

2 ENLARGED SECTION 2
1/8" = 1'-0"



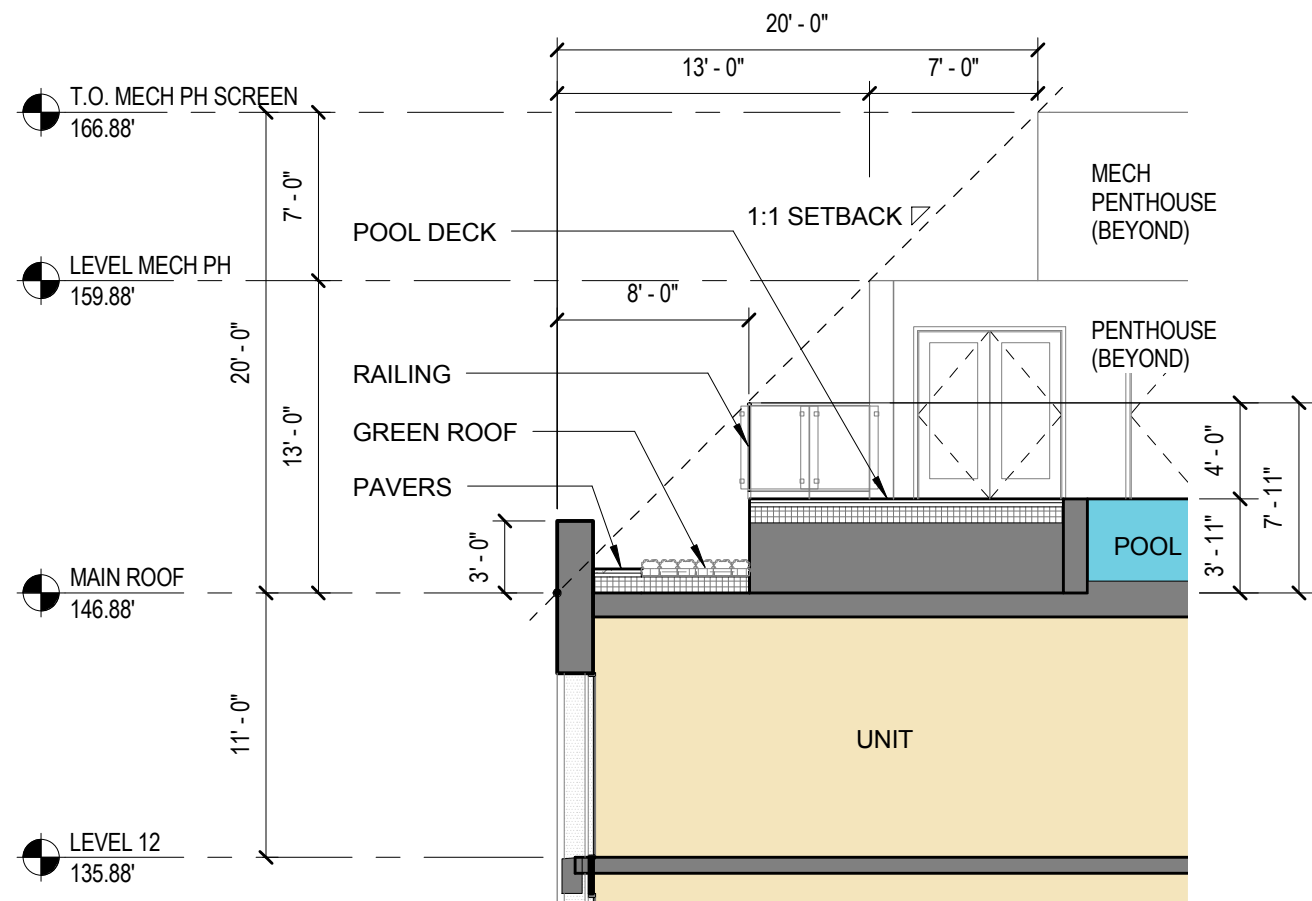

1 ENLARGED SECTION 1
1/8" = 1'-0"

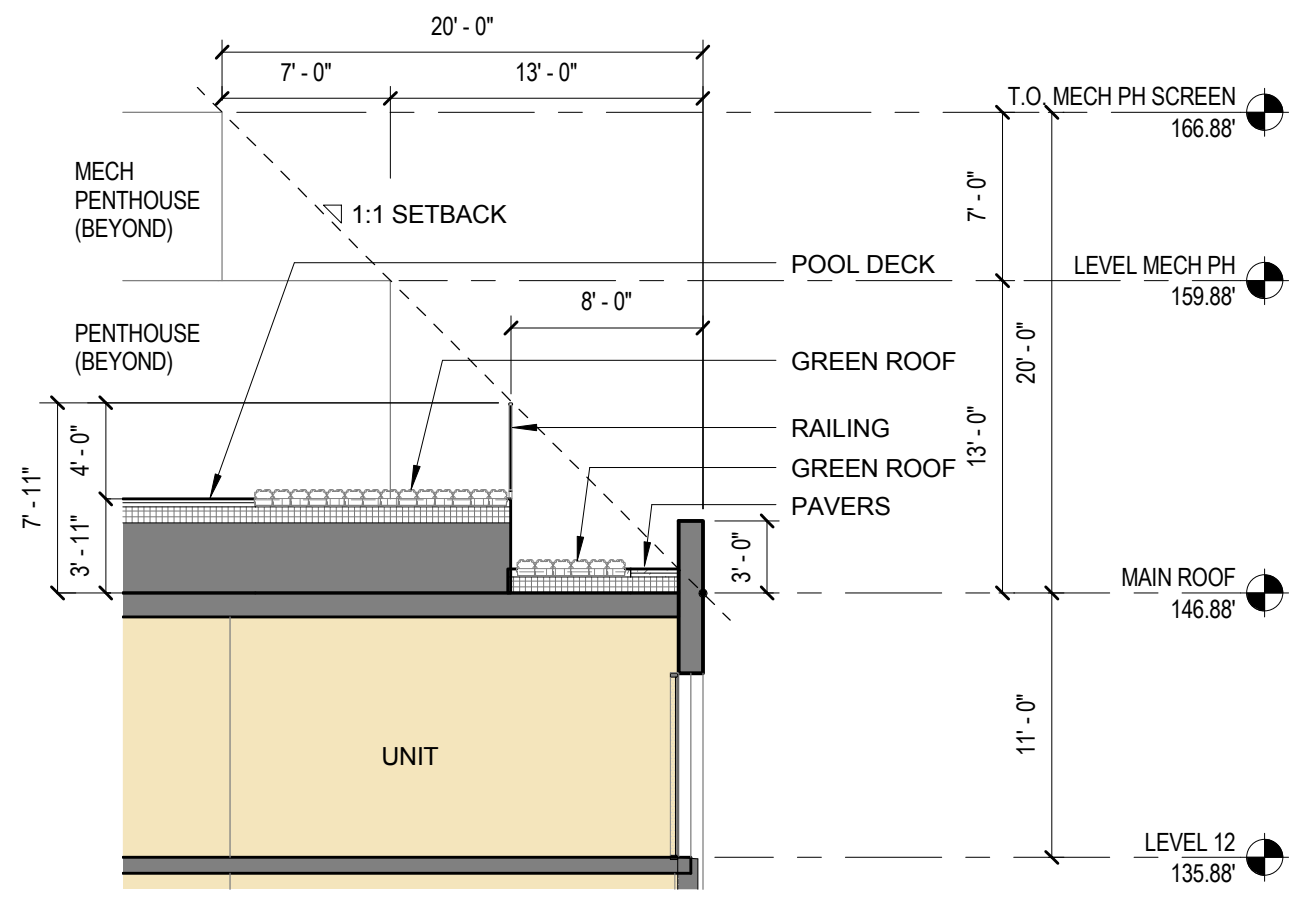

2 ENLARGED SECTION 2
1/8" = 1'-0"

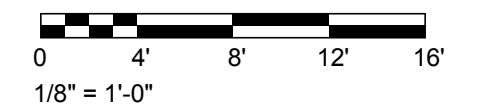

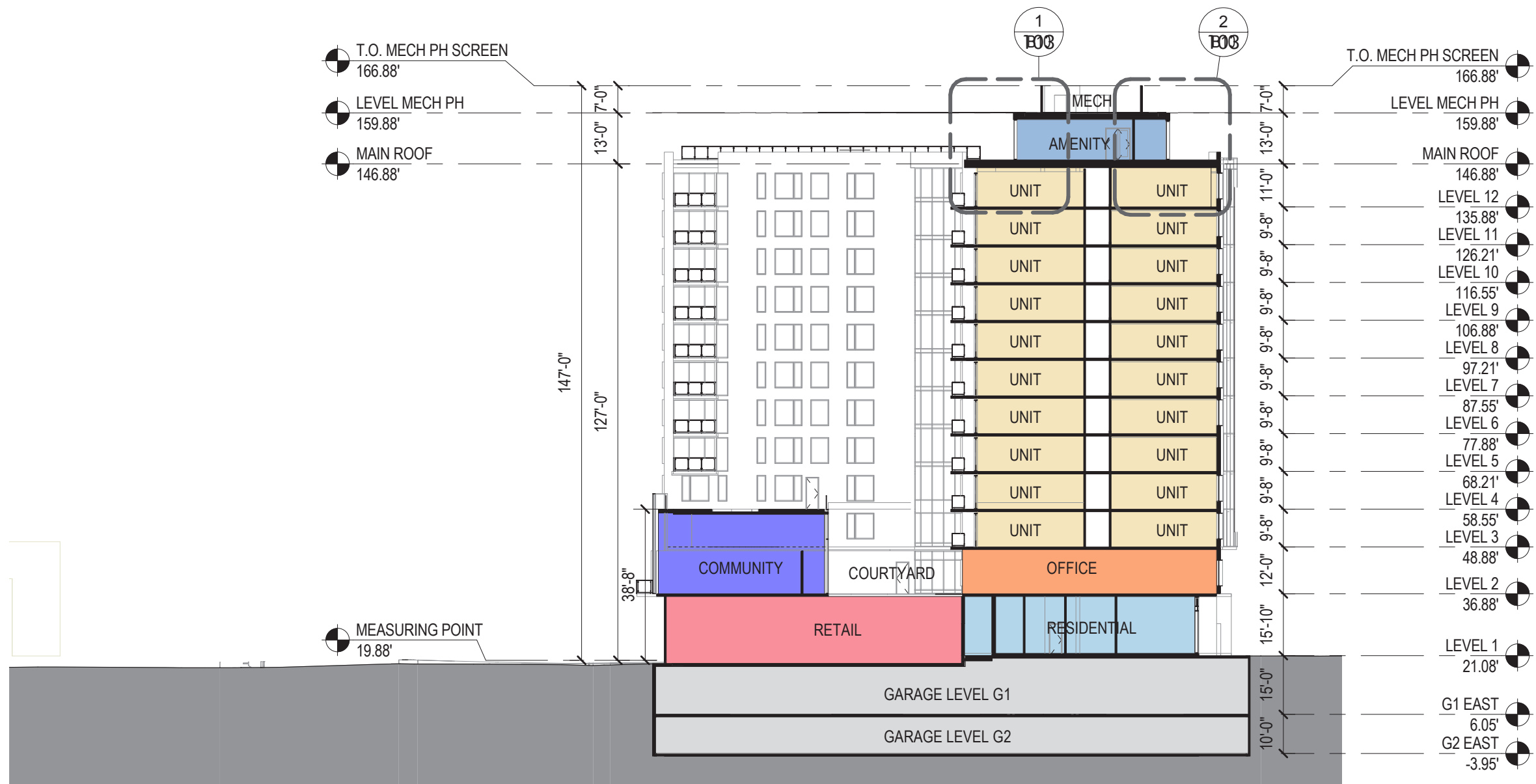

1 PUD - EAST BLDG SECTION - NORTH SOUTH
 1/32" = 1'-0"

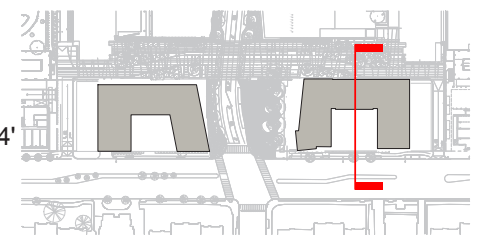
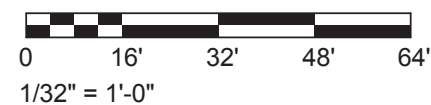

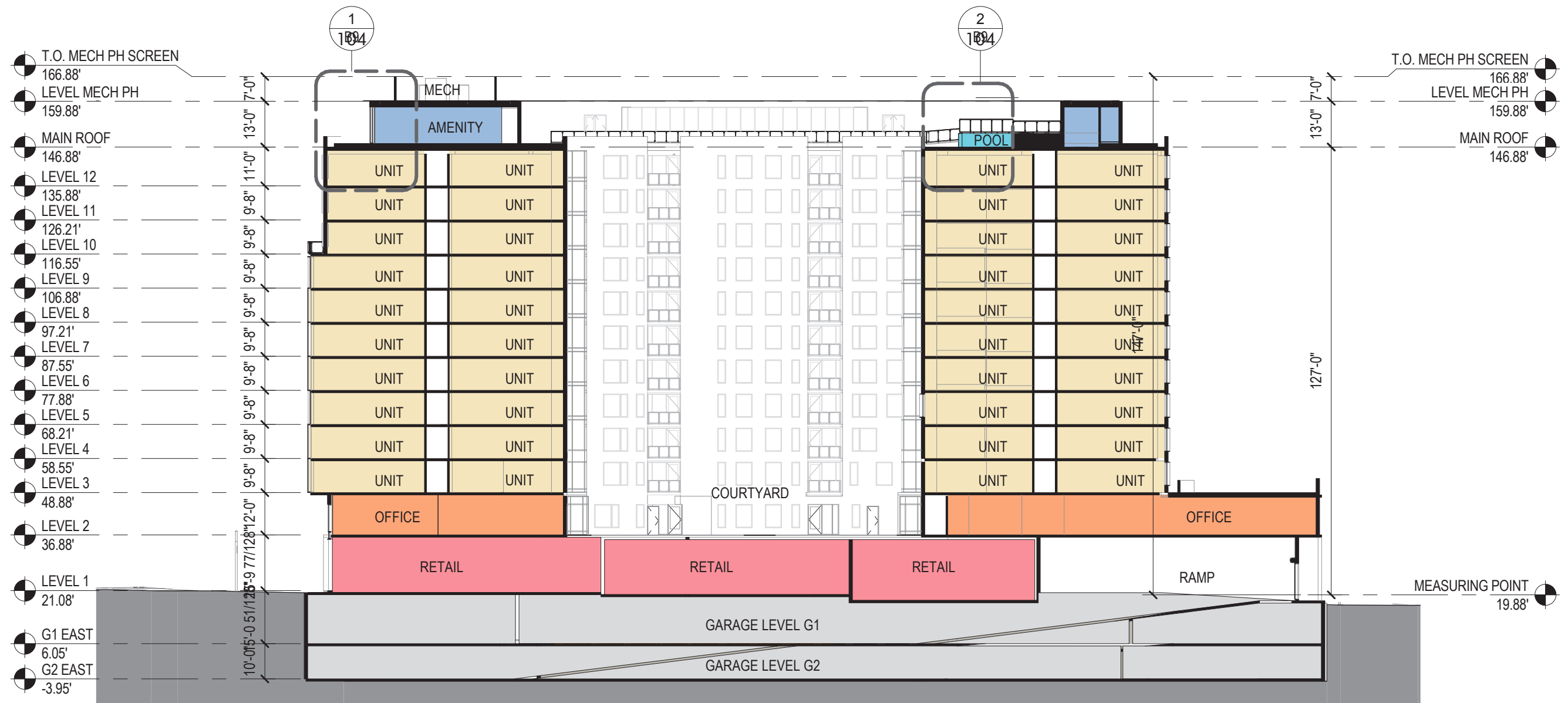

1 PUD - EAST BLDG SECTION - EAST WEST
 1/32" = 1'-0"

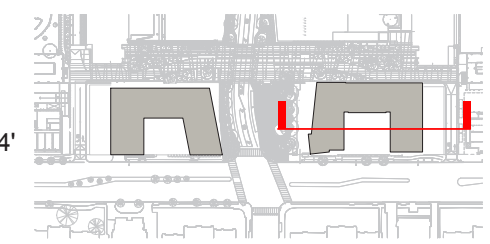
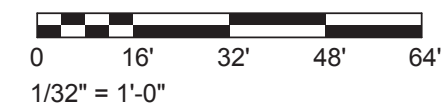

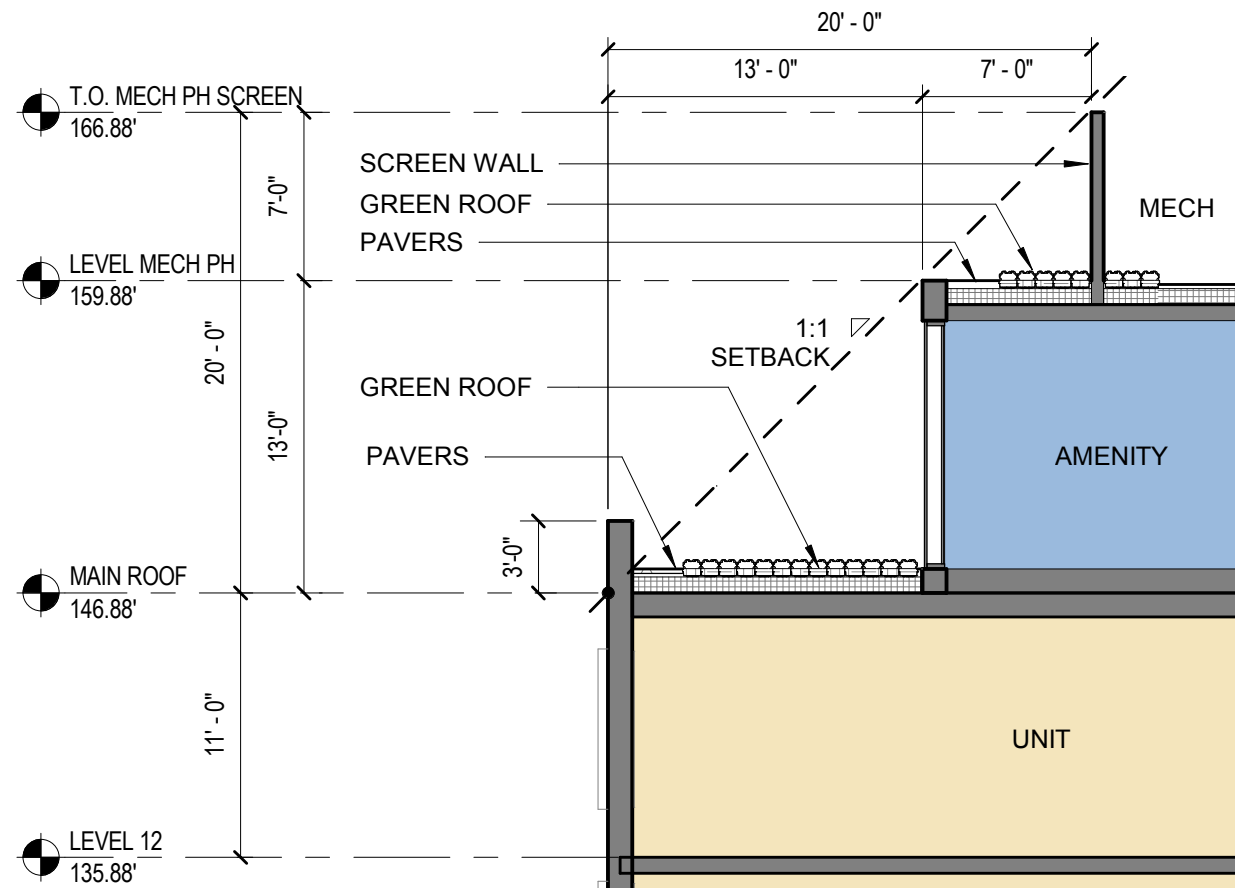

1 ENLARGED SECTION 1
1/8" = 1'-0"

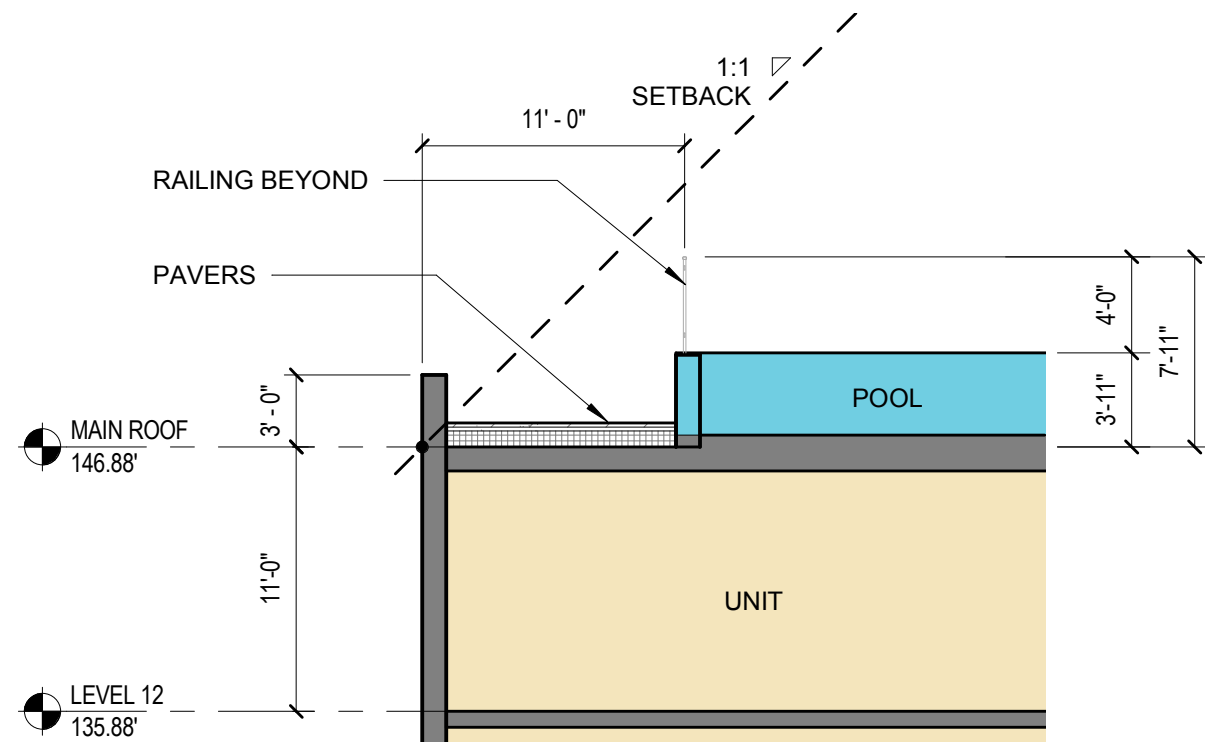

2 ENLARGED SECTION 2
1/8" = 1'-0"



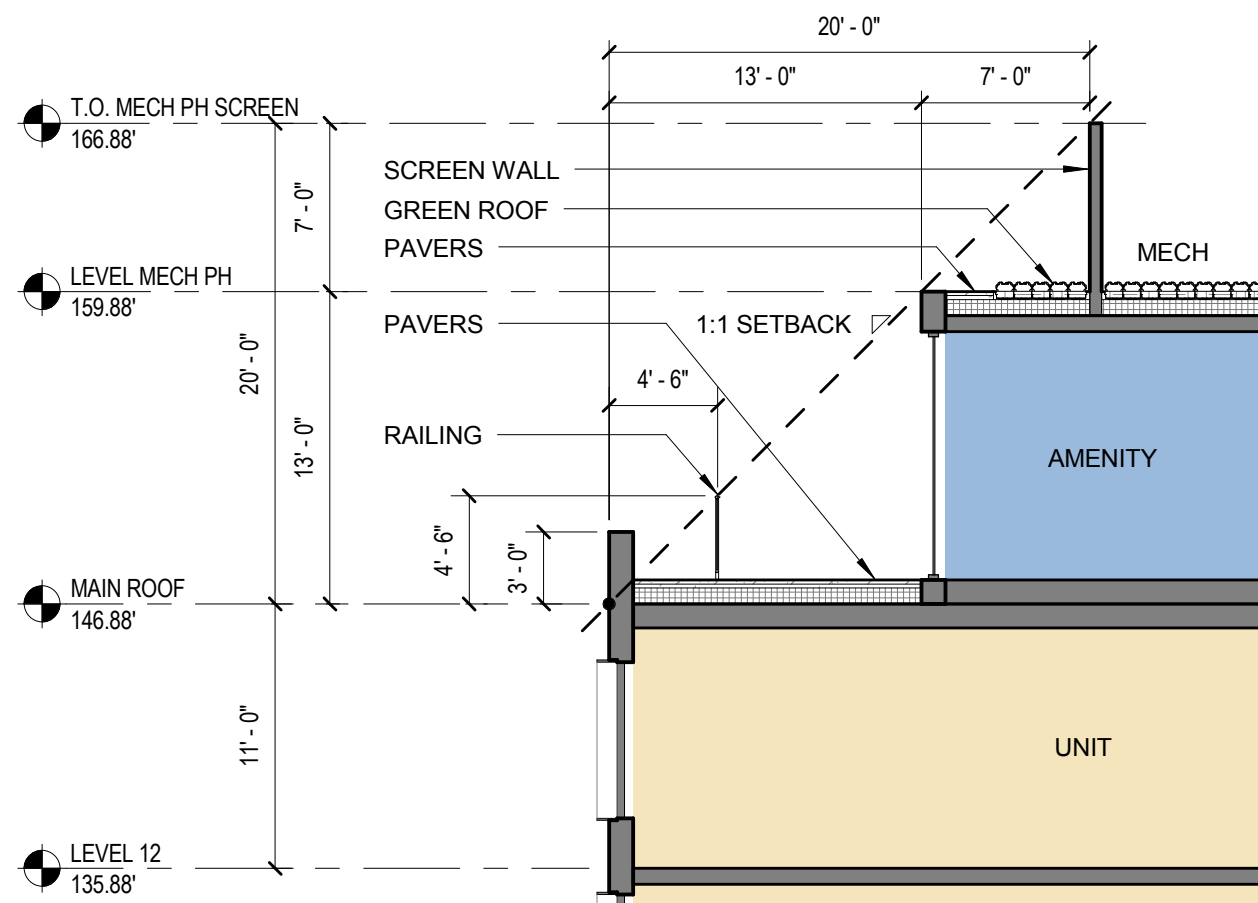

1 ENLARGED SECTION 1
1/8" = 1'-0"

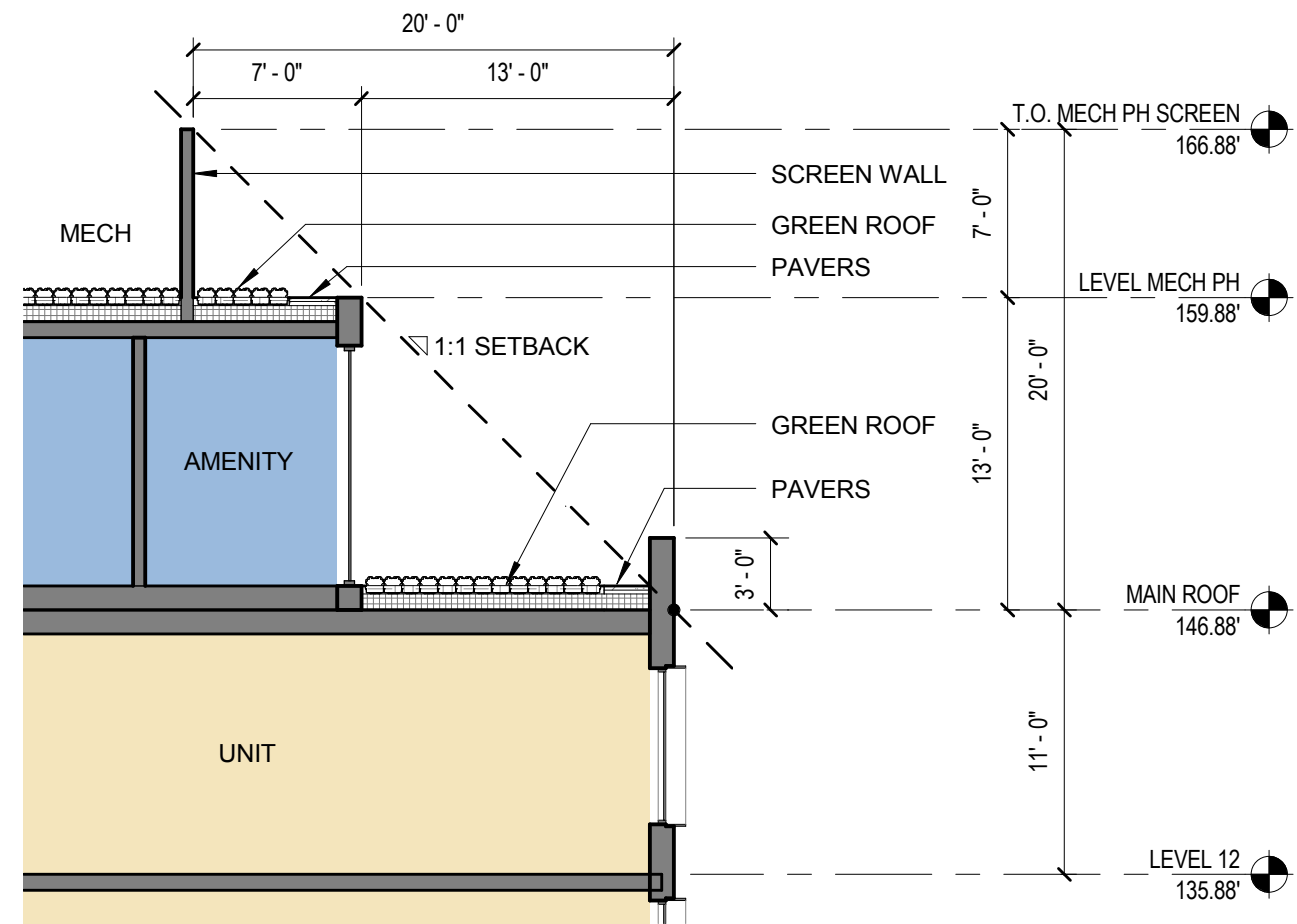

2 ENLARGED SECTION 2
1/8" = 1'-0"



PAGE INTENTIONALLY
LEFT BLANK